

4-Hole Closed Angle Connector

5370 - 5376

Fig. Number	Angle B°	Std. Package	Wt. Each	
			Lbs.	kg
5370	37½	25	.95	(.43)
5371	45	25	.95	(.43)
5372	52½	25	.95	(.43)
5373	60	25	.95	(.43)
5374	67½	25	.95	(.43)
5375	75	25	.95	(.43)
5376	82½	25	.95	(.43)

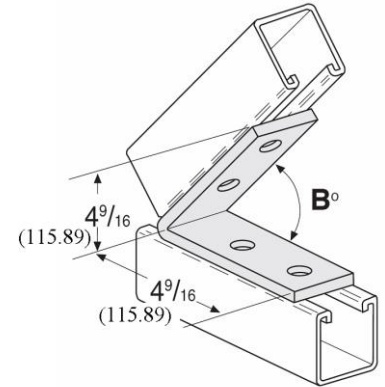

Available in stainless steel. To order, specify 316 and add suffix SS to fig. number. Price on request.

MATERIAL: ¼ X 1⁵/₈ (6.35 X 41.28)

FINISH: Electro-galvanized

ORDERING: Specify figure number and angle "B".

HOLE DIM: 9/16 (14.29) dia. • 13/16 (20.64) from end

Unless otherwise specified, all dimensions on drawings and in charts are in inches and dimensions shown in parentheses are in millimeters.